

ILIFE-V8s

Robotic vacuum cleaner

User Manual

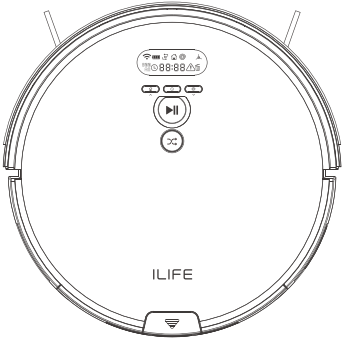

For more detailed information,
please visit: www.iliferobot.com

ILIFE

Dear Customer,

Thank you for purchasing ILIFE V8s robotic vacuum cleaner!
You've joined the millions of people who clean with robots - the smarter way to get it done.

Please take a few moments to read this manual and get acquainted with your robot, to get the best performance from your robot. If you have any problems with your robot please do not hesitate to contact our customer service or visit our website at www.iliferobot.com for more information.

Stay connected with us on Facebook and twitter to enjoy these exclusive benefits:

- Get support tailored to your specific robot, including answers to questions, maintenance tips, video demos, live chat and more.
- Get product updates and other valuable information among the first to find out about new robots, exclusive discounts and special promotions.

Connect with us right now at
Facebook: facebook.com/iliferobotics
Twitter: twitter.com/ILIFEROBOTICS

Enjoy a thorough cleaning every day!
Best regards,
ILIFE Innovation

Important Tips



V8s contains electronic parts. Do Not submerge the robot or spray it with water. Clean with a dry cloth only.

For Best Usage

- Place the charging dock against the wall in a wide open area. Do not put the charging dock near a door or stairs.
- Remove excess clutter on floor before cleaning (e.g. electrical cords, cables, small objects, etc...)
- Choose MAX mode to clean an area of highly concentrated dirt and dust.

Maintain Peak Performance

- Clean the side brush and ventilation unit when they become dirty and replace them if they become damaged. (See figure 1)
- Remove the nose wheel and holder by pulling the wheel straight up. Clean the debris and hair from the wheel cavity as well as the axle that holds the wheel in place. This should be done once a month.
- Empty dustbin and clean filter after each use. Replace a new filter every month.

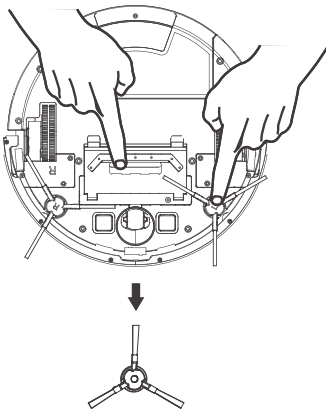

Figure 1

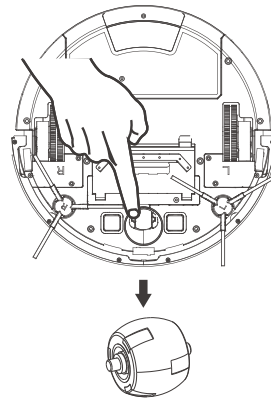

Figure 2

Table of Contents

Safety Instructions	4
Product Composition	6
List of Accessories	6
Robot Anatomy	7
Dustbin / Water Tank	8
Robot Panel Function	9
Product Parameters	10
Product Operating	11
Remote Control Operation	11
Charging Dock	13
Start/Pause/Sleep	15
Schedule cleaning mode	16
Robot Operation	17
Mode Selection	17
Water Tank Operation.....	20
Regular Maintenance	22
Side Brush and Suction Inlet Cleaning	22
Dustbin and Filter Cleaning	22
Water Tank Cleaning	23
Sensors and Charging Contact Points Cleaning	24
Nose Wheel Cleaning	24
Troubleshooting	25
Replace Accessories Regularly	25
Warning Code Table on Display Panel	25

Safety Instructions

Before using this product, please read the following safety instructions and follow all normal safety precautions.

- Read this user manual thoroughly and carefully before using this product.
- Keep this user manual.
- Any operation or use of this product in any way other than that described in this manual may lead to serious injury or product damage.

WARNING

1. Only certified technicians may disassemble the product. Users are not allowed to disassemble or repair the product.
2. Only use the AC adapter provided by the factory. Using other AC adapters may cause electric shock, fire or product damage.
3. Do not touch the power cord, plug or adapter when your hands are wet.
4. Keep loose clothing and fingers away from being drawn into the product's wheels.
5. Keep the robot vacuum away from all flammables.
6. Never clean the robot while it is on the charging dock or plugged in directly. Unplug the robot and turn off power switch when cleaning.
7. Keep the AC power cord tucked away from becoming damaged in any way.
8. This product is to be used only indoors. Not intended for outdoor use.
9. Do not sit on top of the product or attach an object on the top of it.
10. Do not use this product in wet or moist environments.
11. Before use, remove all the objects that could get caught in the brushes or suction passage.
12. Do not place this product on furniture or platforms where it can fall and be damaged.
13. Turn the power switch off when not in use for a long period of time or when transporting the unit.
14. To avoid battery damage please check whether adapter and outlet are properly connected.
15. To avoid any tripping hazards or injuries please inform all the people in the house when this product is in use.

Safety Instructions

16. Do not use this product when dustbin is full.
17. Normal operating temperatures -10 to 50 (centigrade).
18. Do not operate this product in high temperature environments.
19. The battery must be removed from the product before it is scrapped.
20. Unplug the vacuum from power source when removing the battery.
21. The battery is to be disposed of safely.
22. Use factory authorized battery only. Do not use unmatched battery.



NOTE: This product is not a toy and should not be used by children or people with the lack of related experience or knowledge.

Product Composition

List of Accessories

Serial Number	Description	Q'ty
1	Main Body (battery included)	1
2	Charging Dock	1
3	Remote Control (battery not included)	1
4	Power Adapter	1
5	Water Tank	1
6	Mop Cloth	1
7	Cleaning Tool	1
8	User Manual	1
9	Extra Side Brushes	2
10	High Performance Filter	1

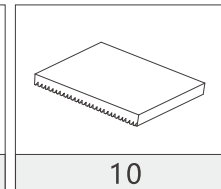
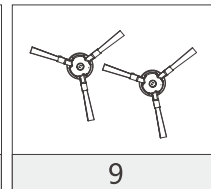
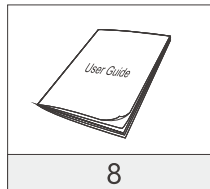
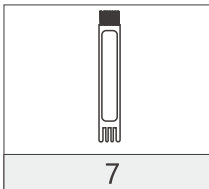
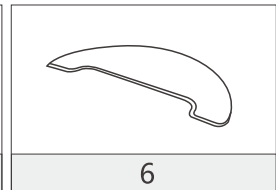
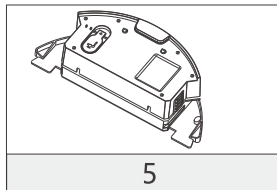
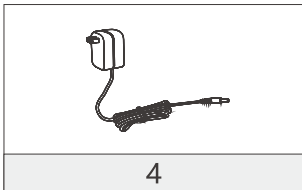
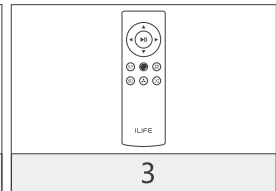
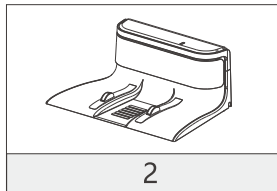
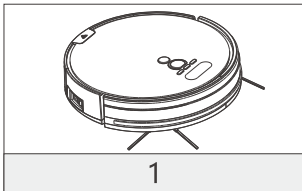

Product Composition

Robot Anatomy

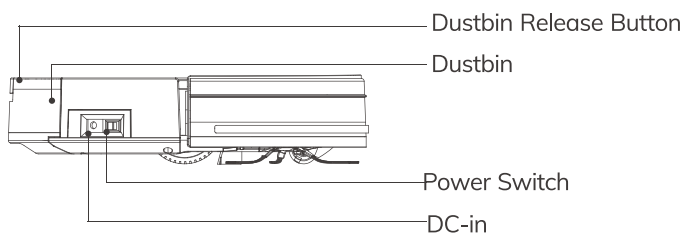
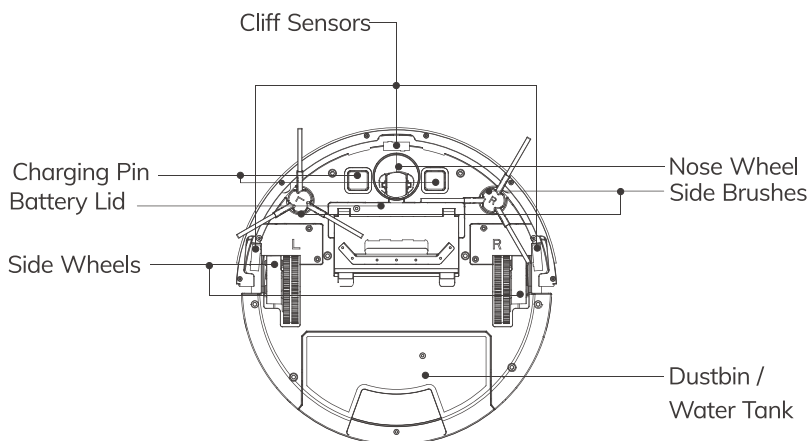
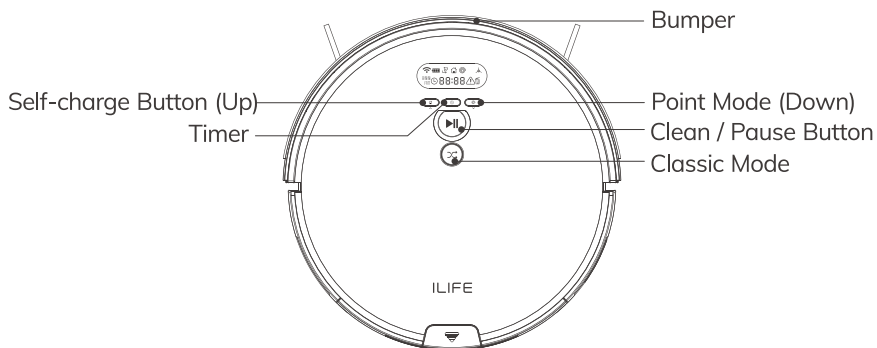

Product Composition

Dustbin

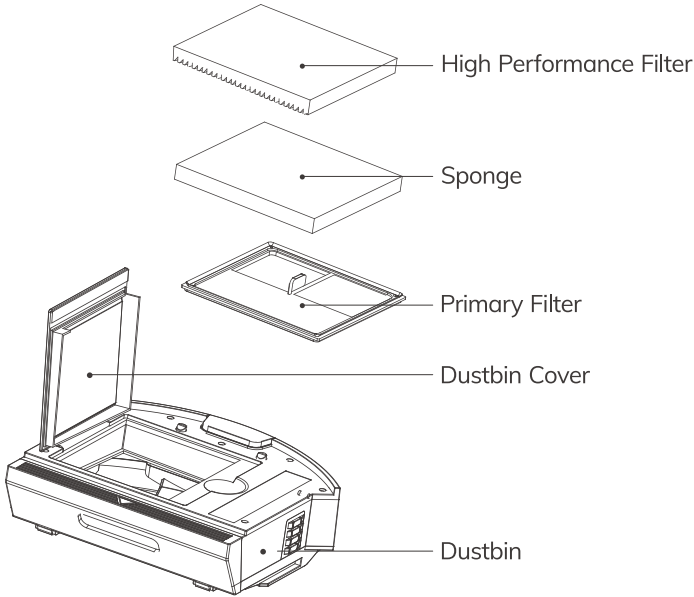



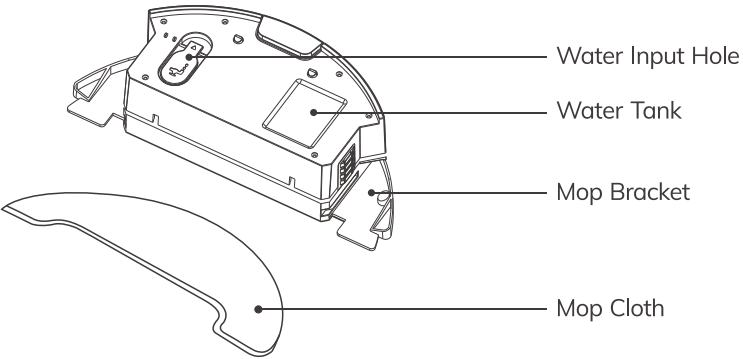











Water Tank



Product Composition

Robot Panel Function

Icons on Display Panel	Icon Description
	Battery
	Trouble Alerts
	Side Brush Malfunction
	Dustbin Malfunction
	Edge Mode
	Self-charge
	Spot Mode
	Time Display
	12hour Format
	Timer

Button Icons	Icon Description
	Clean / Pause Button
	Classic Mode
	Timer
	Self-charge Button(Up)
	Spot Mode (Down)

Product Composition

Product Parameters

Classification	Item	Detail
Mechanical Specifications	Diameter	330mm
	Height	81mm
	Net weight	2.7kg
Electrical Specifications	Battery	Li-ion
	Power	25W
	Charging type	Auto Charging/Manual Charging
Cleaning Specifications	Capacity of dustbin	0.75L
	Capacity of water tank	0.3L
	Cleaning mode	Classical/Spot/Edge/Daily Schedule
	Duration per recharge	<350mins
	Duration per cleaning	>80mins
Button Types		Mechanical Buttons
Display Panel		LCD Screen

Reminder :

The Company reserves the right of final decision on the interpretation of these Terms and Conditions.

Product Operation

Remote Control Operation

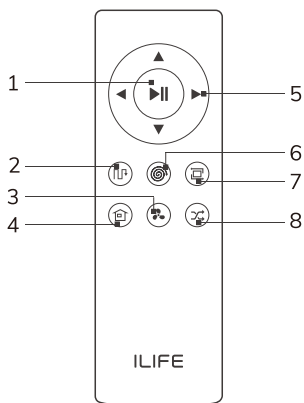

1. Clean/Pause Button
2. Path Mode
3. MAX Mode
4. Self-charge Button
5. Direction Buttons
6. Spot Mode
7. Edge Mode
8. Classic Mode

1 Clean/Pause Button

- Press the button to switch the robot from Sleep Mode to Select Mode.
- Press the button when in Select Mode to start cleaning.
- Press the button to Pause the robot during its operation.

2 Direction Buttons

A. “▲” Forward

Press the button to move the robot forward.



B. “◀” Left Press the button and the robot will turn left.

C. “▶” Right Press the button and the robot will turn right.

Note: “▲” “▼” “◀” “▶” cannot be used during a cleaning cycle.

Product Operation

3 MAX Mode

Under the Cleaning Mode, to clean dust traffic area, please press “” to increase the suction level and then vacuum will go to deep cleaning mode, "Hi" will be shown on the display panel. Press “” again to switch back to normal cleaning mode. "Lo" will be shown up on the display panel.

4 Self-charge Button

Press the button and the robot will return to the charging dock for recharging.

5 Edge Cleaning Button

Press the button to start border cleaning.

6 Spot Mode Button

Press the button to start the spot cleaning.

7 Path Mode

Press the button to start cleaning under Path Mode.

8 Classic Mode

When the robot finishes cleaning an area in Classic Mode, it will move along the walls to the next area. Classic Mode is suitable for carpet cleaning.

Reminder :

Please install two AAA/R03 batteries before using the remote control.
Please take out the batteries if the remote control won't be used for a long time.

Product Operation

Charging Dock

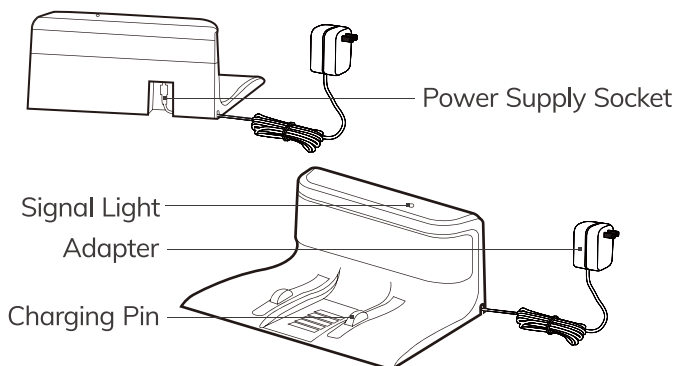

1 Placement of Charging Dock

- Connect the adapter with the charging dock.
- Placement of the charging dock: place the charging dock against the wall horizontally and there must be no object on the left and right side within one meter and in the front within two meters. There must also be no reflective object such as a mirror around the dock.
- Connect the power.

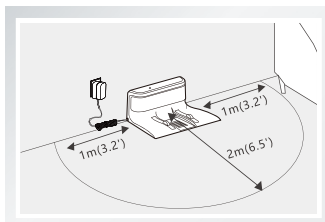

* Reminder:

When the charging dock is connected to the adapter, the signal light of the dock will light up.

2 Turn on The Robot

- Turn on the power button on the side, "—" for ON, "O" for OFF.

* Reminder:

After the robot finishes its work, please do not turn it off; keep it recharged for next run.

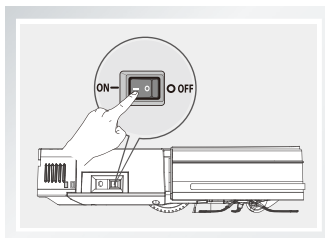

Product Operation

3 Robot Charging

A. Auto Charging

- Under the Auto Mode, the robot will automatically search for the charging dock when the power is low.
- Under the selected mode, the robot will begin to search for the charging dock when the respective button (🏠) on the remote control is pressed.

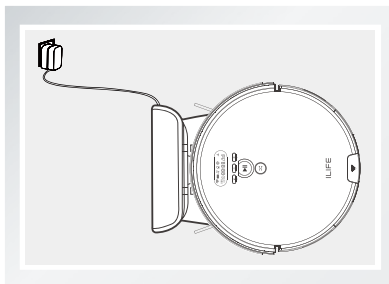

* Reminder:

Please keep the charging pins clean in daily use to ensure a good connection.

B. Manual Charging

- Turn on the power button on the side of the robot, connect the adapter with the robot and then plug the adapter into the power socket.

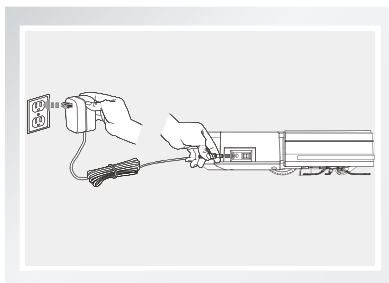

* Reminder:

- Charge for 12 hours for the first time.
- Please leave the robot on the charging dock in daily use and make sure that the charging dock is connected to the power and the main switch is on.
- If you won't use the robot for a long time, please fully charge it, turn off the power and store it in a well-ventilated dry place.
- Please don't use manual recharge mode under the Schedule Mode, otherwise the robot can't perform the function of Schedule Mode.

Product Operation





Start/Pause/Sleep

Sleeping mode: the power button is ON, the main switch and display panel does not light up, and the robot is in the pause status.



Selected mode: the power button is ON, the main switch pulses and the display panel lights up, and the robot is in the pause status.

Cleaning mode: the robot is the status of operation, the green light is on, and the display panel displays the status of operation.



1 Start

- Make sure that the power switch on the side of the robot is "ON".
- Press  button or  button to start operation.
- Press  button or  on the remote control to start operation.

* Reminder:

If the robot is in the Sleep Mode, press button  to wake up the robot and enter the Select Mode, then press button  once again, and the robot will automatically start operation.

2 Pause

- "Pause" will switch the robot from Cleaning Mode to Select Mode, and it can be enabled by pressing button  on the remote control or button  on the robot.

* Reminder:

You can operate the machine again after it's paused.

3 Sleep







- To enter the Sleep Mode:
A: Press button  for three seconds.
B: The machine will automatically enter the Sleep Mode if no action is taken for 3 minutes.

Product Operation

Schedule cleaning mode

- Create a schedule and let it work automatically everyday.

1 88:88 Clock Time Setup





- A. When the vacuum is turned on, it will beep while pressing the button  for 2 seconds, and the Hour part on the display screen will blink, showing that it has entered the state of time setting. Button  and  are used to adjust the time numbers. Press button  to switch between hour, minute, 12/24 hour.
- B. 12/24 Hour Format Setup: Press button  to switch between 12/24 hour format, and the display screen will show ON/OFF respectively.
- C. When time setting is completed, press button  to save the setup.

* Reminder:

- The robot will exit the setting mode automatically after 15 seconds without any operation, and the setup will not be saved.
- The current setup will not succeed if button  isn't pressed.

2 ☹88:88 Schedule Cleaning Timer Setup



Once the schedule is set up successfully, the robot will work on time every day at the certain time. If the power switch at the side of the robot is turned off, the schedule will be lost and need to be reset.

- A. When the vacuum is turned on, quickly press the button , it will beep and the signs of "☹" on the display screen will blink, showing that it has entered the state of schedule setting mode. Press button  to switch between hours and minutes. Press button  and  to adjust the time numbers.
- B. when the schedule setting is completed, press button  to save the setup.

Attention:

- The robot will exit the setting mode automatically after 15 seconds without any operation, and the setup will not be saved.
- The current setting will not succeed if button  isn't pressed.

3 Cancel The Schedule

When the machine is turned on, quickly press the button , it will beep and the signs of "☹" on the display screen will blink, showing that it has entered the state of schedule setting mode. Press button  to cancel the schedule, and the display screen will show "--:--". If the button  is pressed again, the schedule will be opened, and the display screen will show the previous schedule time.

Product Operation

Robot Operation



1 Clean/Pause Button

- A. Press the button to switch the robot from Sleep Mode to Select Mode.
- B. Press the button when in Select Mode to start cleaning.
- C. Press the button to Pause the robot during its operation.

2 Classic Mode

- A. Press the button to switch the robot from Sleep Mode to Select Mode.
- B. Press the button under the Select Mode to start cleaning in the Classic Mode.
- C. Press the button to Pause the robot during its operation.

3 Direction Buttons

- A. “” Under selected mode or cleaning mode, press the button to let vacuum go back to charge station. Press the button to increase the number under Schedule/Time setting mode.
- B. “” Under select mode or cleaning mode, press the button to start spot cleaning. Press the button to decrease the number under Schedule/Time setting mode.

Mode Selection

There are several cleaning modes to fit various floor conditions for deep cleaning. You can make a choice with the remote control.

- You can use the remote control to switch between various modes.
- You need to make sure that the robot is awake before starting any of the following modes. The power is on, the button light is green. The display panel is on, and the robot is paused.

1 Path Mode

Press the button  on the robot or remote control to start path mode, the robot start cleaning in path mode, automatically calculates the missing area during the cleaning process, cleaning more efficient.

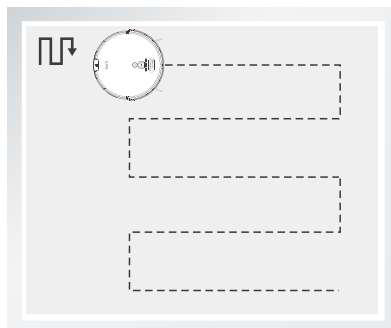

* Reminder:

Press  on the remote control also can activate the path mode.



Product Operation

2 Spot Mode

- Place the robot near the required area, and then press the button  on the robot or button  on the remote control to start cleaning in Spot Mode.

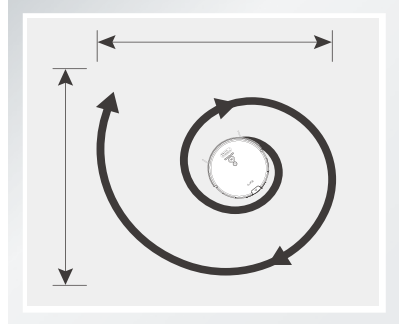

3 Edge Mode

- Place the robot near the required area, and then press button  on the remote control to start cleaning in Edge Mode.

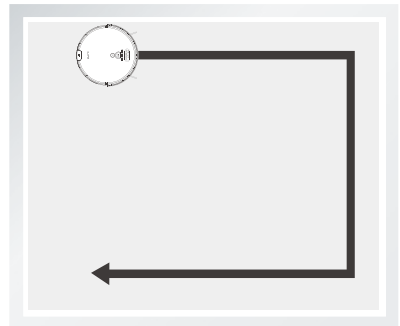

4 MAX Mode

- If there is heavy dust during the cleaning process, please press the button  on the remote control and "HI" will show up on the display panel to enhance the vacuum power for deep cleaning; press again to switch back to normal vacuum power, and "LO" will show up on the display panel.

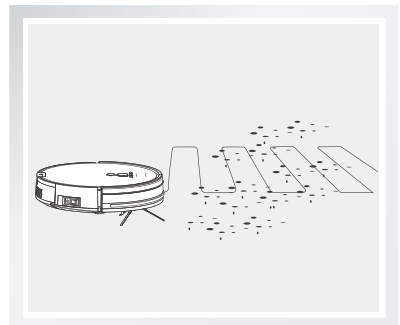

Product Operation

5 Classic Mode

When the robot finishes cleaning an area in Classic Mode, it will move along the walls to the next area. Classic Mode is suitable for carpet cleaning.

*Reminder:

Press the button  on the robot or remote control to start Classic Mode.

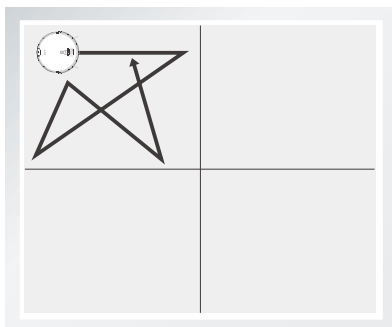

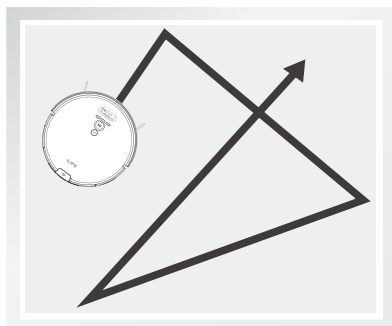

6 Mopping Mode

- Under the mopping mode, the robot will start mopping automatically. During the process of mopping, press button  on the remote control to switch the speed of water dropping.



7 Self-charge Mode

- The robot can sense lower power during the cleaning process and automatically activate Self-charge Mode and search for the charging dock.

*You can also use the button  on the robot or button  on the remote control to command the robot to activate the mode.

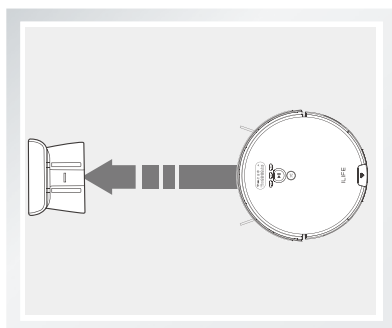

Product Operation

Water Tank Operation

The product is equipped with water tank components, and if there is a demand for the mop, it is recommended to clean the area with the dustbin first. Then change the dustbin to the water tank components to carry out the mop work.



- * If during the mopping process the robot is stopped to either add water or clean the mop, the robot will reset and plan a new pathway from where it is started, either add water or clean the mop. In order to achieve a better cleaning, it is recommended for single room use.
- * When cleaning a second room, it is recommended to manually move the robot to the corresponding room and add water and clean the cloth as needed.

- * Please do not use the water tank components on the carpet or rugs. Please fold the edge of the rugs or block carpet areas to avoid cleaning them during the mopping mode during the mopping mode.
- * Please pay attention during the mopping mode, timely add water or clean the mopping pad. The water tank needs to be removed when adding water.
- * Be sure to remove the water tank components when charging.

1 Add Water

- Open the water injection cap, fill the water with the water cup, and pour the water slowly into the tank.

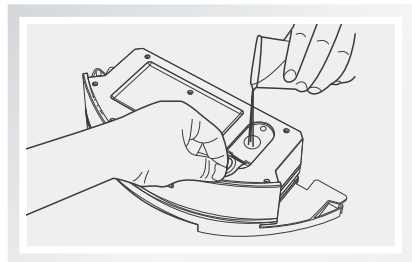

Product Operation

2 Place The Mop Cloth

- Close the water injection cap tightly, put on the mop cloth and strap the two elastic bands.

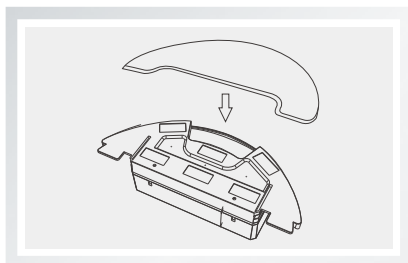

3 Install Water Tank Components

- Press the button at the end of the dustbin, remove the dustbin, and replace it with the water tank components.

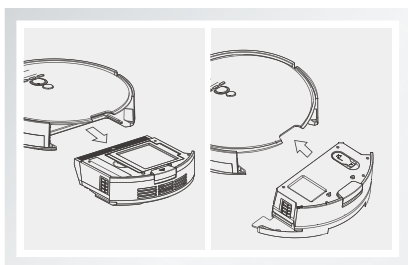

4 Mop The Floor

- Start any cleaning mode on demand, and the robot will perform mopping.

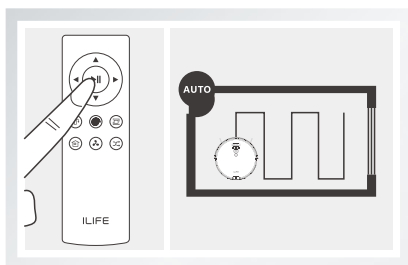

Regular Maintenance

* Please turn off the robot and unplug the charging dock when cleaning the robot and its accessories.

Side Brush and Suction Inlet Cleaning

- Please clean the side brush and suction inlet when they are dirty and replace them if needed.

Dustbin and Filter Cleaning

- Please clean the dustbin and filter after each use of the robot as instructed below.

*** Reminder:**

- A. Remove the dustbin and check if there is any debris in the suction inlet, and then clean it.
- B. A primary filter is replaceable and should be washed with water after having been in use for about 15-30 days, after which it should be dried in a cool and well-ventilated place and not to be squeezed.
- C. High Performance Filter can not be cleaned with water.
To prolong the life of the filter it can be cleaned by shaking the filter.

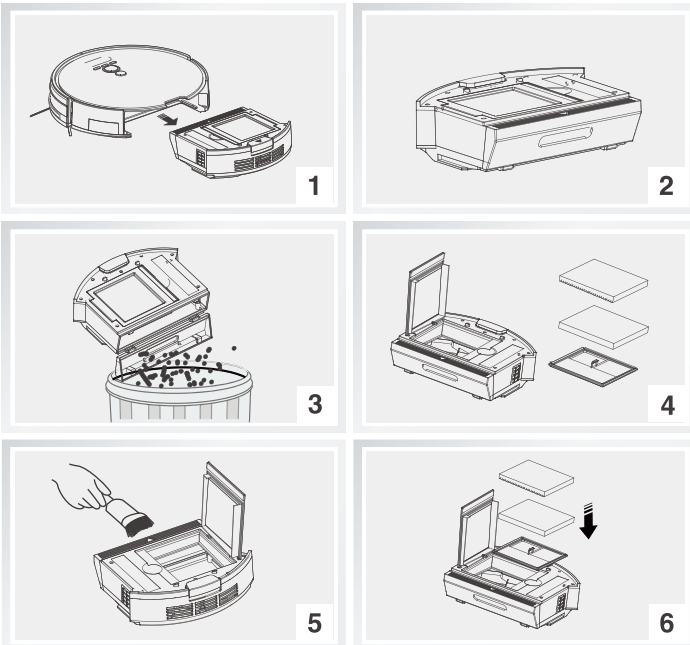

Regular Maintenance

Cleaning of Water Tank Components

1 Clean The Mop Cloth

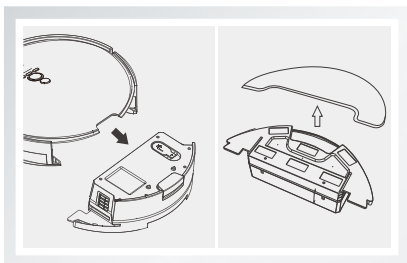

Remove: after mopping, please remove the water tank components and the mop cloth.

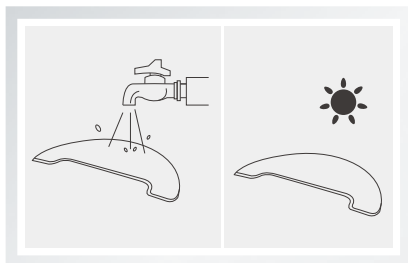

Maintenance: rinse and air dry the mop cloth.

2 Clean The Water Tank

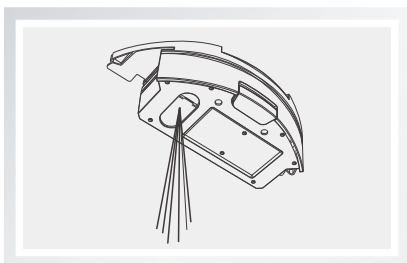

Remove: after mopping, remove the mop cloth and the components, drain the remaining water in the water tank.

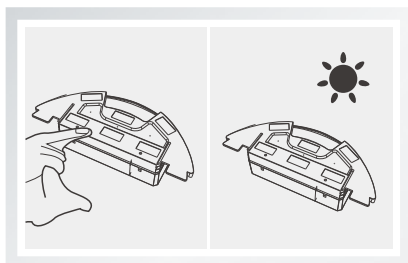

Maintenance: dry the water tank by hand and then air dry it.

Regular Maintenance

Sensors and Charging Pins Cleaning

- Please use a cleaning tool or soft cloth to clean the sensors or charging pins as illustrated below.

*** Reminder:**

The charging pins should be cleaned in a timely manner if it's contaminated.

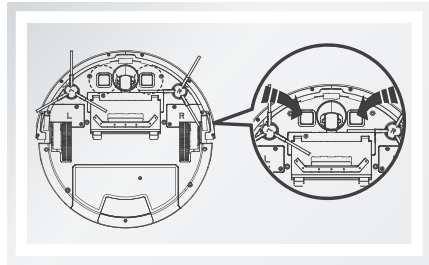
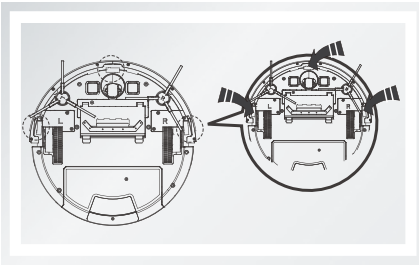

Nose wheel

Make sure the nose wheel housing is not jammed by debris, otherwise the robot's cleaning performance will be affected.

1. Pull the wheel up and out vertically and clean the wheel, wheel holder and wheel housing.

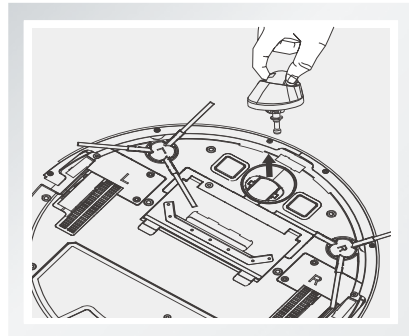

Troubleshooting







Replace Accessories Regularly

Accessories	Maintenance	Replacement
Dustbin	After each use	N/A
High Performance Filter	Weekly (Twice a week for families with pets)	Bimonthly
Spinning Side Brush	Weekly	Depends
Charging Dock	Weekly	N/A











Warning Code Table on Display Panel

When a problem happens, the red light will be on and short prompt tones will sound.

(• number of alert sounds)

Serial Number	Alert	Error Message	Cause	Solution
01	•	E11 	Left wheel malfunction	Check left wheel
02	•	E12 	Right wheel malfunction	Check right wheel
03	•	E13  	Left side brush malfunction	Check left side brush
04	•	E14  	Right side brush malfunction	Check right side brush
05	• •	E21 	Robot suspended	Put the robot on the floor

Troubleshooting

Serial Number	Alert	Error Message	Cause	Solution
06	• •	E22 	Lower view component malfunction	Clean the lower view sensor
07	• •	E23 	Bumper malfunction	Check the bumper
08	• • •	E31 	The robot is trapped	Move the robot to an open space and restart it
09	• • •	E32  	Dustbin malfunction	Check the dustbin
10	• • •	E33 	Water container malfunction	Check the water container
11	•• •• •	E41 	Battery malfunction	Restart the robot
12	•• •• • •	E42 	Front view component malfunction	Check the front view component
13	•• •• • • •	E43 	Gyro module malfunction	Restart the robot
14			The dustbin is full or the filter needs to be cleaned	Clean the dustbin or the filter
15		LO 	Low Battery	Recharge

* Reminder:

If the problem remains unresolved, please try the following:

1. Switch the power button on the side of the robot off and on and restart it.
2. If the problem remains unresolved after restart, please contact ILIFE Customer Service listed at end of manual.